

**Standard Features:**

- Advanced unidirectional suspension system
- Premium high-density, high-resiliency foam seat
- Tight back and seat cushion
- Single-needle top-stitch
- Lifetime warranty on frame and suspension
- Quick-ship delivery

**Options:**

- Solid wood legs available in Natural Walnut or Gray Ash

**Additional Power Options:**

- Motorized recliner with an in-arm control panel that is easy to use and includes a USB charging port
- Motor has a five-year warranty
- Lithium-ion battery pack available
- Battery pack has a one-year warranty

*Please use actual leather, fabric, Crypton®, Sunbrella® and Ultrasuede® swatches when specifying furniture as the colors shown may vary due to the printing process.*

Wall Clearance is 16"

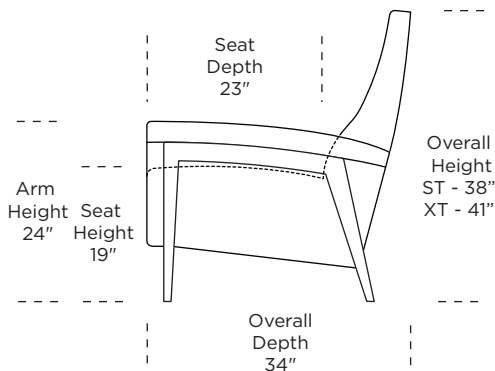
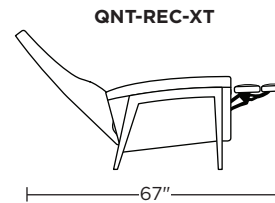
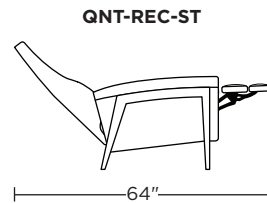
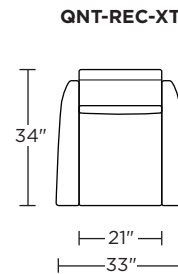
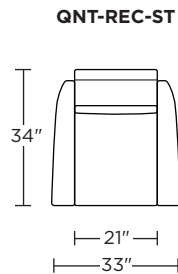
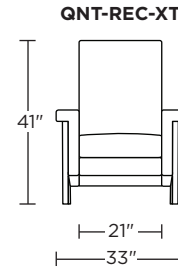
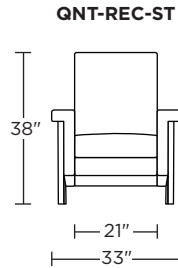

HANSEN  
INTERIORS

Scale: 1/4 inch = 1 foot  
All dimensions are approximate and subject to change.  
Specify components from the sitting position.

V.05.07.20