

CORRIDOR[®] 8172

AUDIO TOWER



HANSEN
INTERIORS

INSTRUCTION MANUAL

LET'S GET STARTED.

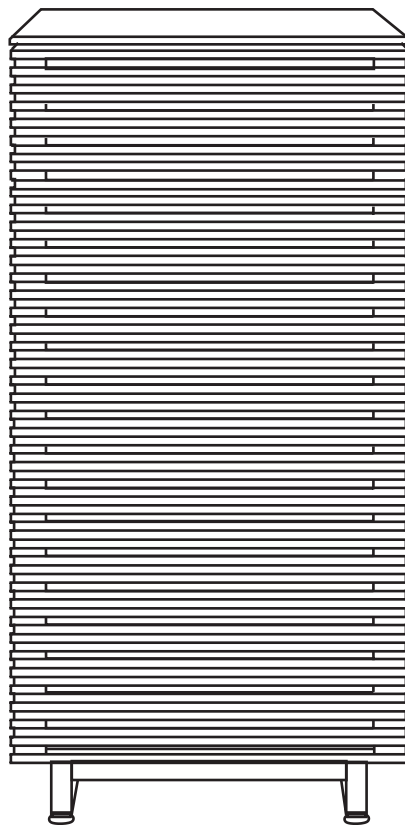

DESIGN MATTHEW WEATHERLY

BDi

BDIUSA.COM



Congratulations on the purchase of your Corridor Audio Tower 8172 from BDI. Your cabinet has been designed to provide a lifetime of enjoyment. This manual will provide you with assembly instructions and other helpful information that will ensure that you get the most out of your cabinet. Please save it for future reference.

Your Corridor audio tower has been engineered for simple assembly. Please follow these directions carefully to prevent any damage.

Should you need further assistance, contact BDI at customerservice@bdiusa.com.

ENJOY!

HARDWARE AND COMPONENTS

Unpack and identify the parts listed below. The assembly workspace should be a non-marring surface such as carpet. For missing hardware pieces, please contact BDI Customer Service at customerservice@bdiusa.com.

Do not use power tools for assembly of this product.

For all other concerns, please contact your BDI retailer.

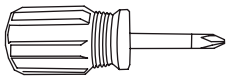

PART #	A
DESCRIPTION	Phillips Screwdriver
QUANTITY	1



PART #	B1
DESCRIPTION	Hex Wrench
QUANTITY	1



PART #	B2
DESCRIPTION	Open Mouth Wrench
QUANTITY	1



PART #	B3
DESCRIPTION	Small Hex Wrench
QUANTITY	1

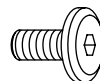

PART #	D
DESCRIPTION	1/4-20 x 10mm Machine Screw
QUANTITY	12

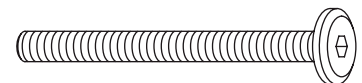

PART #	M
DESCRIPTION	1/4-20 x 63mm Machine Screw
QUANTITY	1

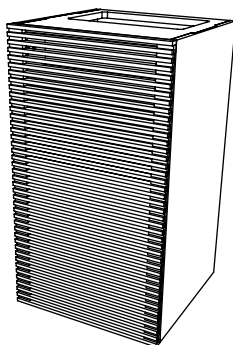

PART #	C
DESCRIPTION	Cabinet
QUANTITY	1

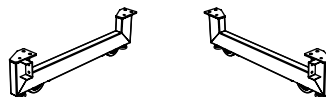

PART #	E (left) & F (right)
DESCRIPTION	Metal Leg
QUANTITY	1 of each

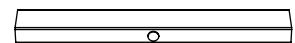

PART #	N
DESCRIPTION	Stretcher
QUANTITY	1

HARDWARE AND COMPONENTS

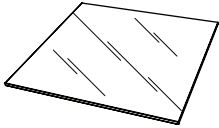

PART #	G
DESCRIPTION	Glass Top
QUANTITY	1

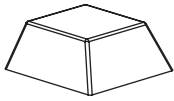

PART #	H
DESCRIPTION	Rubber Bumper
QUANTITY	4

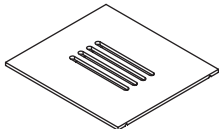

PART #	I
DESCRIPTION	Large Adjustable Shelf
QUANTITY	2

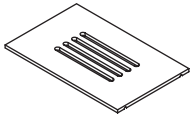

PART #	J
DESCRIPTION	Small Adjustable Shelf
QUANTITY	1

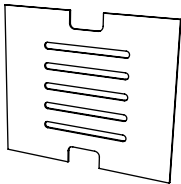



PART #	K
DESCRIPTION	Back Panel
QUANTITY	1



PART #	L
DESCRIPTION	LP Storage Bars
QUANTITY	3

Slide **(E & F) Metal Legs** into **(N) Stretcher** and attach by using **(B1) Hex Wrench** and **4 (D) Screws**. Fully tighten all screws.

	PART/DESCRIPTION	QTY
	B1-HEX WRENCH	1
	D-SCREW	4

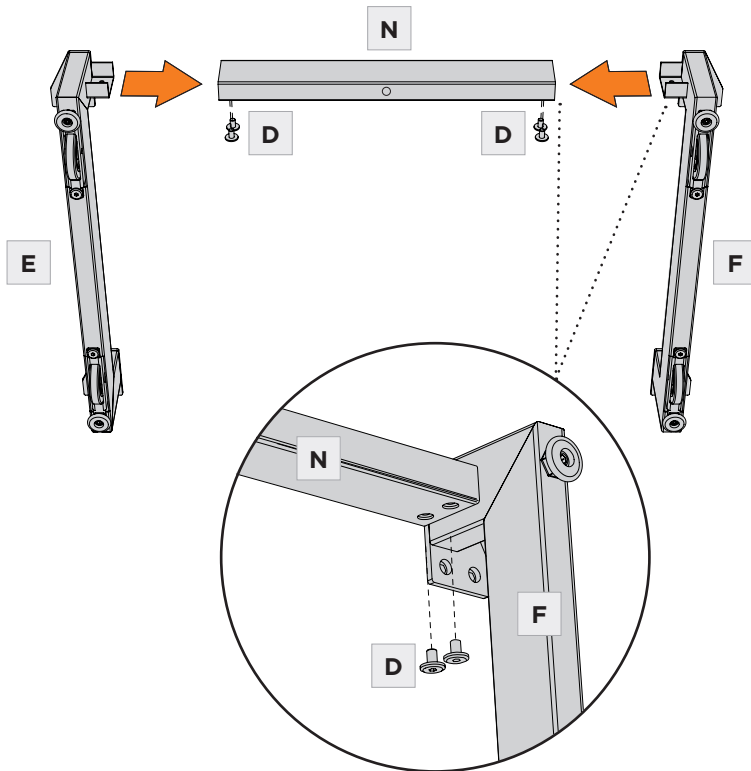

For your convenience, wheel assembly is pre-installed. Wheels can be removed if desired.

Removal of wheels (optional):

Detach **Wheel Assembly** from **(E & F) Metal Legs** by removing the **Leveler** and **Screw**.

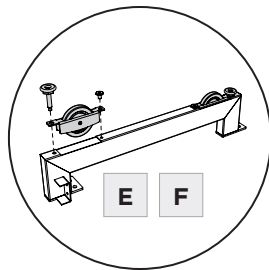

Reinstall **Leveler** to **(E & F) Metal Legs**.

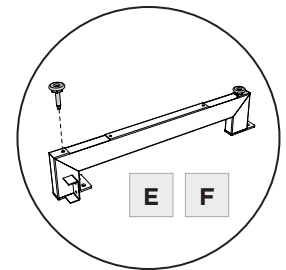



STEP 2. ATTACH THE BASE

ASSEMBLY

Carefully lay **(C) Cabinet** on its back. Prop up the bottom edge with a book. Using **(B1) Hex Wrench**, attach the base assembly to the bottom of the **(C) Cabinet** with **(D) Screws** and **(M) Screw**.

Note: Each of the metal legs has levelers that can be adjusted using the **(B2) Open Mouth Wrench**.

	PART/DESCRIPTION	QTY
	B1-HEX WRENCH	1
	D-SCREW	8
	M-SCREW	1

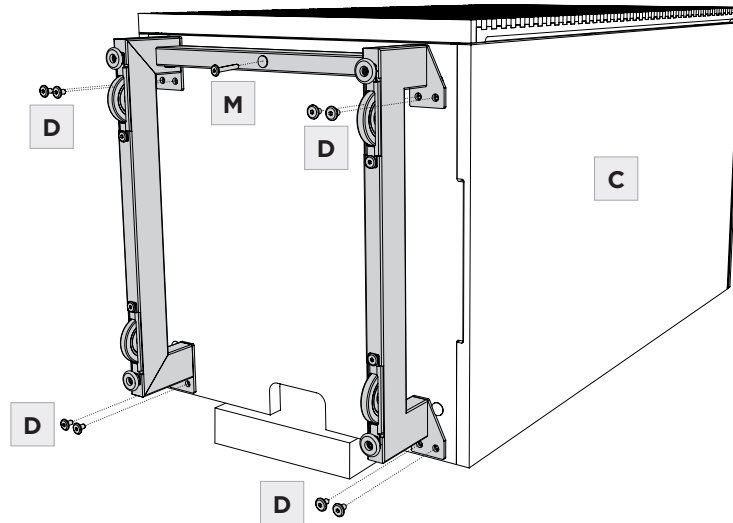

ASSEMBLY

STEP 3. INSTALL RUBBER BUMPERS AND PLACE GLASS TOP

Position the cabinet upright and remove paper backing from **(H) Rubber Bumpers** and place near corners of the top of the cabinet (within 1" of the edge). Place **(G) Glass Top** on top of **(C) Cabinet** centered left to right and front to back.

	PART/DESCRIPTION	QTY
	H-RUBBER BUMPER	4

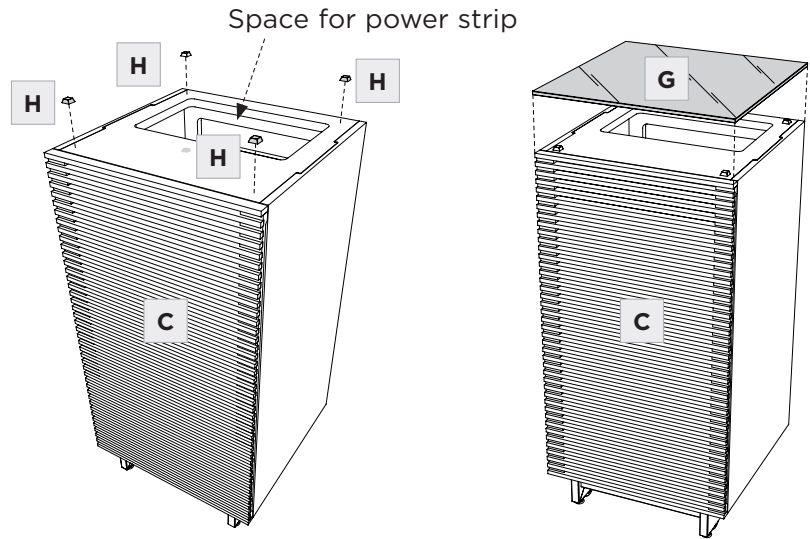

ASSEMBLY

STEP 4. INSTALL BACK PANEL

Install **(K) Back Panel** to the backside of the **(C) Cabinet** by inserting top edge in upper channel then tipping bottom edge forward and into lower channel.

Note: Velcro straps are included for your convenience to facilitate wire management.

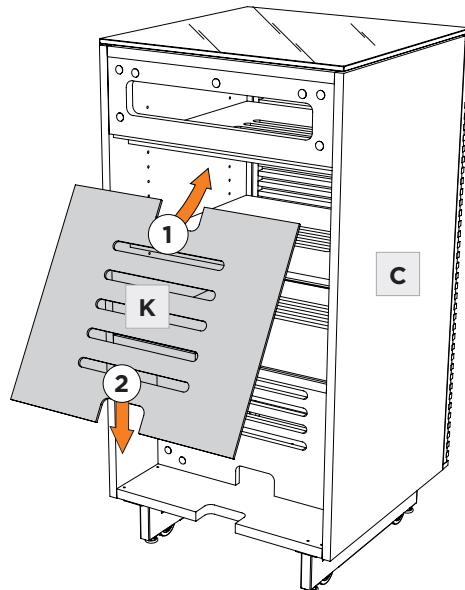

If desired, lift **(I) Adjustable Shelf** away, loosen & remove related **Shelf Support Pins**, reinstall the **Shelf Support Pins** at desired height, then reinstall **(I) Adjustable Shelf**.

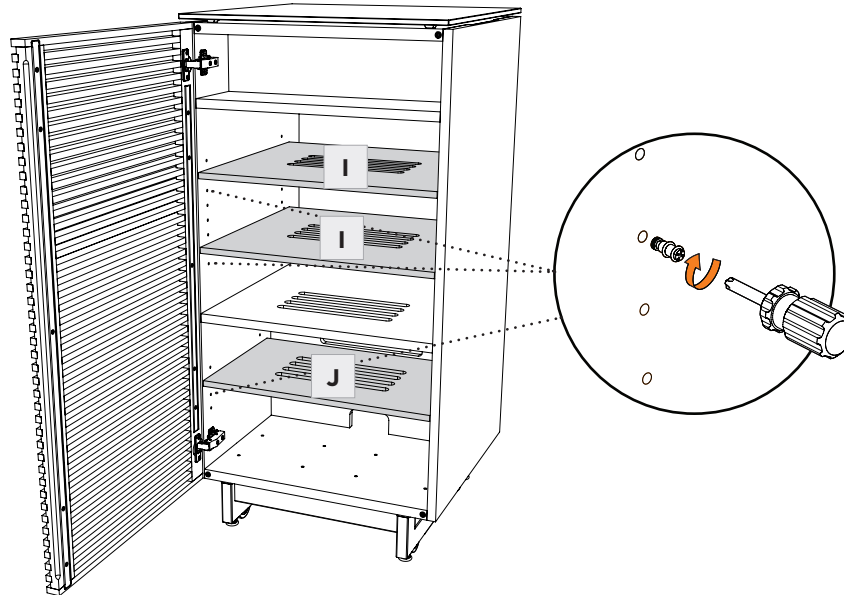

This cabinet is designed to store LP Records by placing **(L) LP Storage Bars** into designated holes in bottom of **(C) Cabinet**. **(L) LP Storage Bars** can be stored by placing them in designated holes in back of **(C) Cabinet** when not in use (see below).

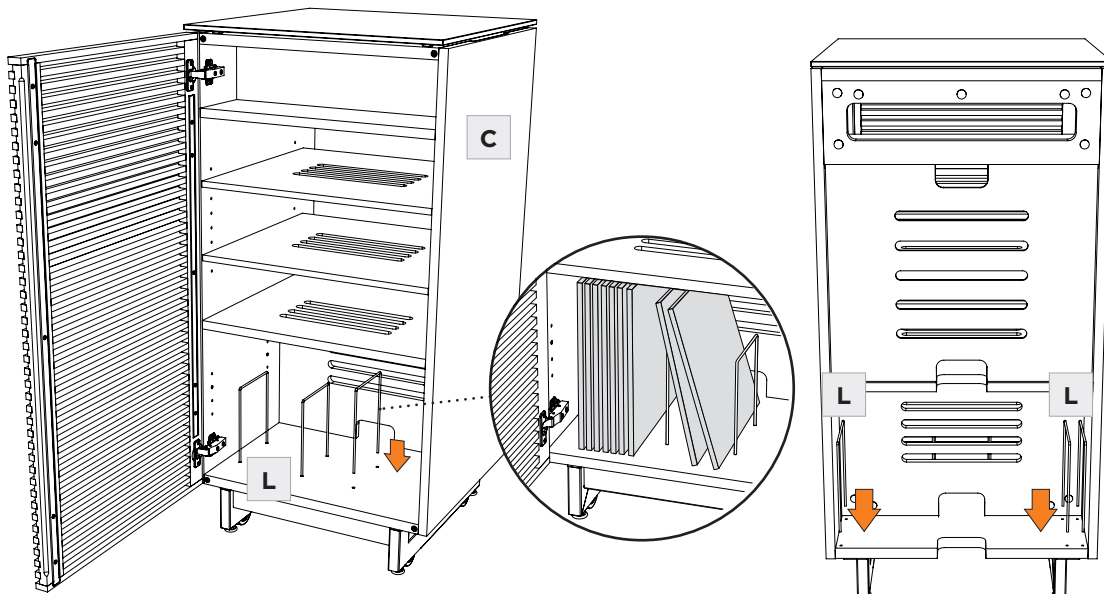

The door on the Corridor AV Tower can either hinge left or right. To change sides, remove the 1 wood screw and 2 machine screws on each hinge plate using a **(A) Phillips Screwdriver** that secure the hinge plates to the cabinet. Rotate the door 180° (up side down) and reattach the door with the machine screws going into the threaded inserts on the other side of the cabinet as illustrated. Adjust the door catches: dial in the one on the hinge side and dial out the catch on the unhinged side. Adjust the door so it aligns with the cabinet (see next page). Once the door is aligned properly with the cabinet, drive 1 wood screw into one of the front holes on each hinge plate to keep the door from shifting downward (optional).

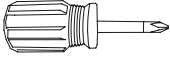
	PART/DESCRIPTION	QTY
	A-PHILLIPS SCREWDRIVER	1

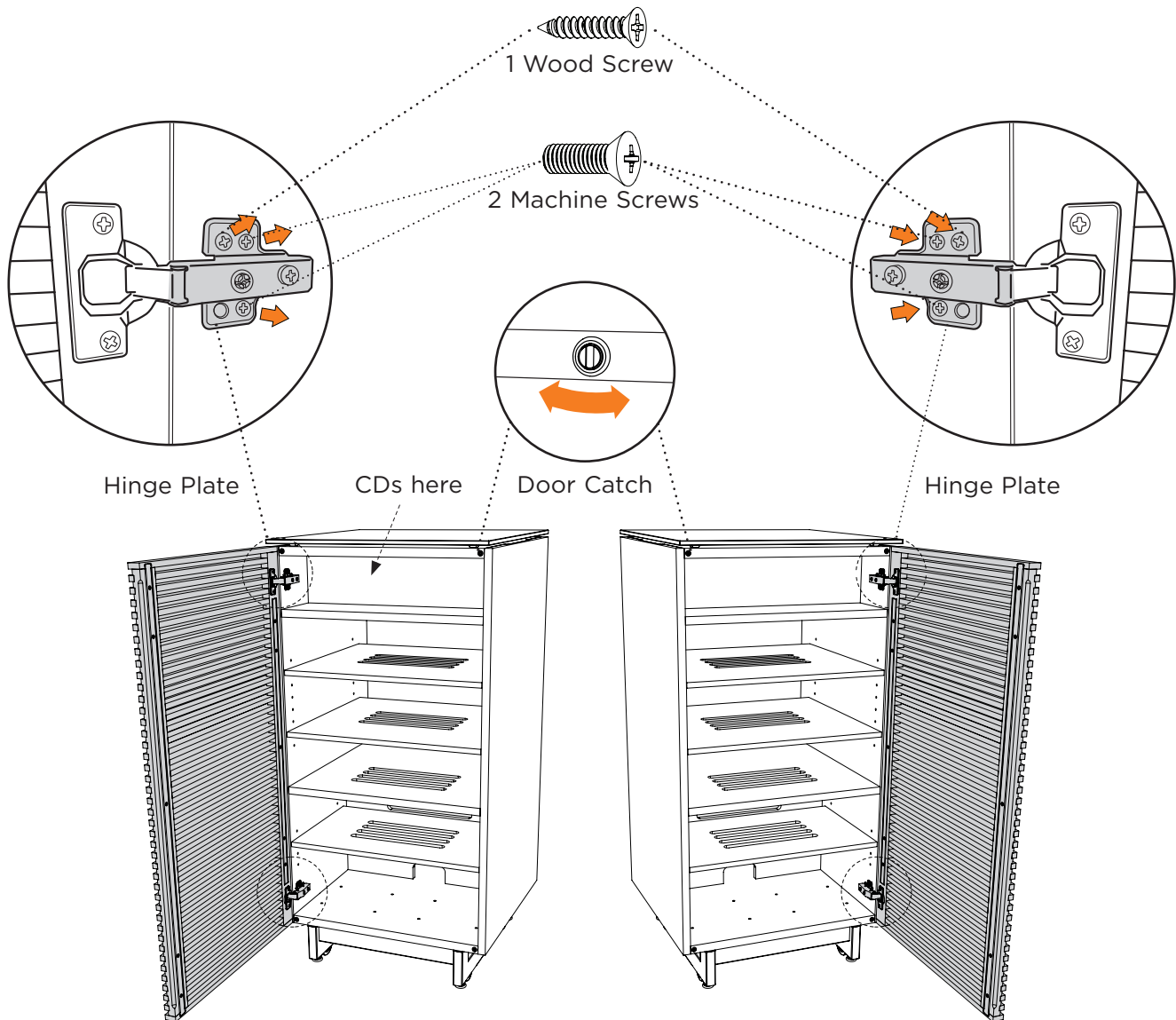

LEVEL CABINET

FINE TUNING

Levelers are integrated into each leg assembly and are accessed at the bottom of each cabinet leg using the **(B2) Open Mouth Wrench**. If your floor is uneven, you may extend one or more levelers to attain a level, stable cabinet placement. Turning the leveler clockwise will extend the leveler; turning it counter-clockwise will retract it.

	PART/DESCRIPTION	QTY
	B2-OPEN MOUTH WRENCH	1

DOOR ALIGNMENT

FINE TUNING

These steps are to be followed after you have unpacked and completed the simple assembly instructions for your Corridor AV cabinet. Due to jostling in freight or perhaps an uneven floor, the doors on your Corridor cabinet may not appear to be in perfect alignment. Making a few minor adjustments can rectify this situation. Be aware that depending on your situation, patience and a bit of trial and error are required. The high-quality European hinge hardware is infinitely adjustable, but changing one element can cause the need for further adjustments. Through a little adjustment, you can modify the orientation of the cabinet doors to make sure that they are sitting perfectly on your Corridor unit.

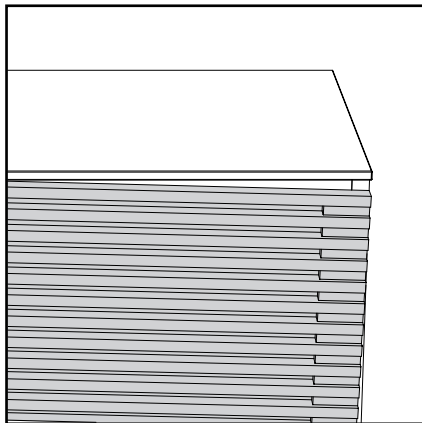

INCORRECT!
Door is out of alignment with the rest of the unit.

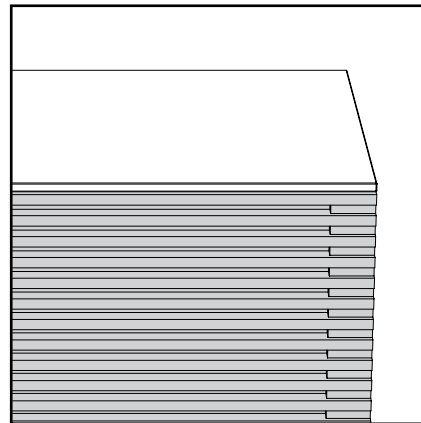

CORRECT!
Door is sitting squarely and evenly spaced on tops and sides.

The doors on your cabinet should be evenly spaced and the doors should open and close freely without rubbing against the door frame.

If the cabinet's doors appear out of alignment, this condition can be corrected with minor adjustment to the European hinges on each door.

Use a **(A) Phillips Screwdriver** to adjust Corridor's door hinges:

- By adjusting **Screw 1**, the door will move LEFT or RIGHT within the frame. Make minor adjustments at both top and bottom hinges for best results.
- By adjusting **Screw 2** the entire door will move IN or OUT, opening or closing the gap between the door frame and cabinet. (This screw rarely needs adjustment.)

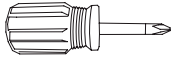
	PART/DESCRIPTION	QTY
	A-PHILLIPS SCREWDRIVER	1

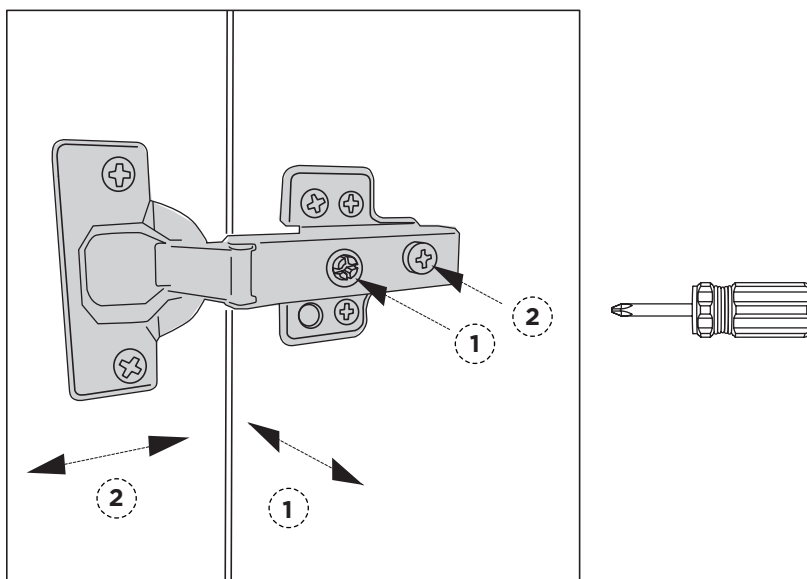

If your door is not straight, the door can be straightened by adjusting the depth of the set screw found in the middle of the 2 metal bars on the back of the door.

	PART/DESCRIPTION	QTY
	B3-SMALL HEX WRENCH	1

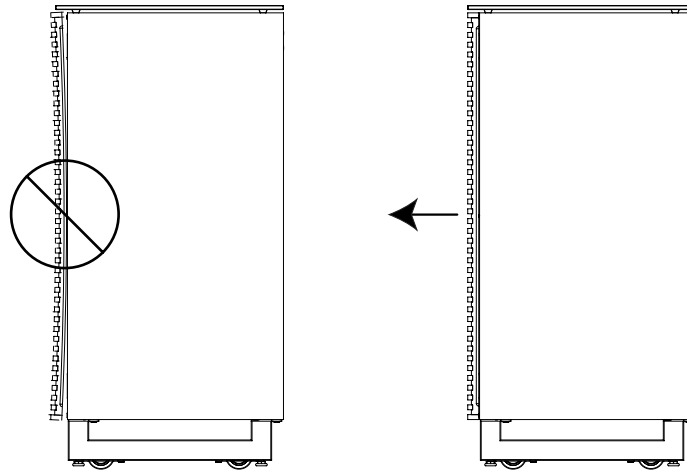

Use the **(B3) Small Hex Wrench** to adjust:

- Turning the set screws clockwise will push the middle of the door outward.
- Turning the set screws counter-clockwise will push the middle of the door inward.

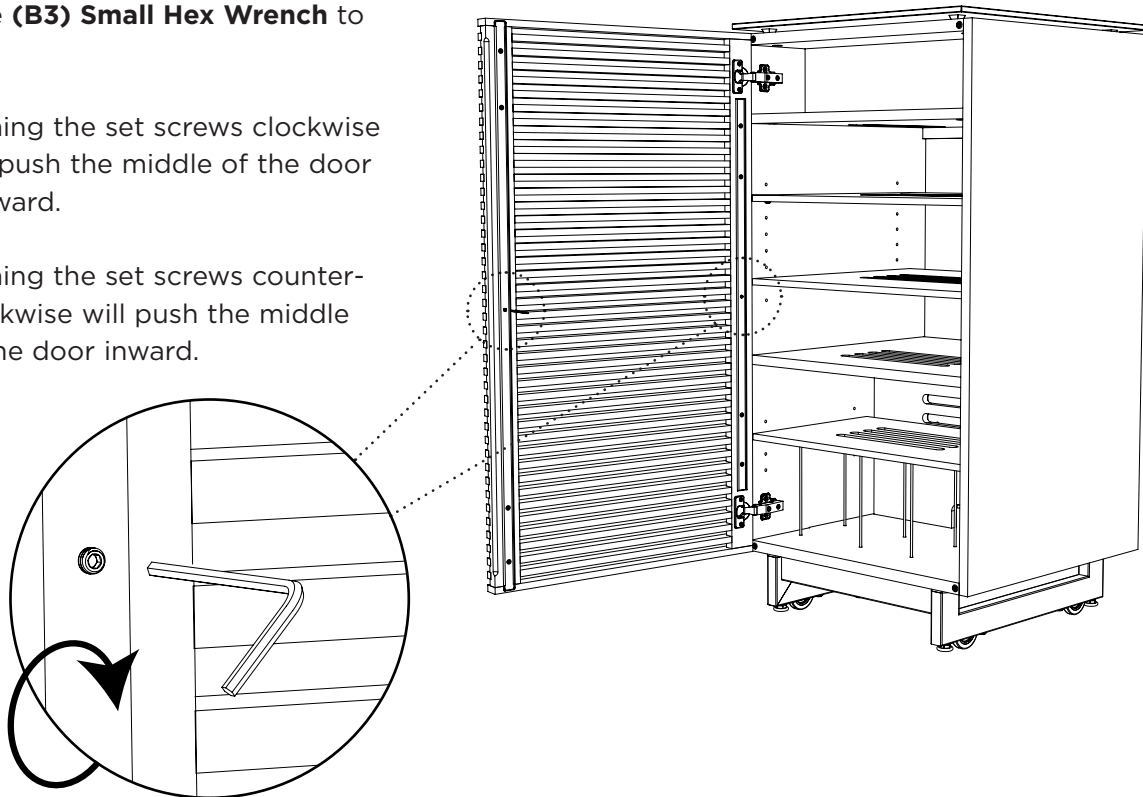

CARE & MAINTENANCE

GLASS

Glass surface is maintained using household glass cleaner and a paper towel or cloth.

SATIN-ETCHED GLASS

This uniquely smooth-to-the-touch glass surface can be regularly maintained using household glass cleaner and a paper towel or cloth. Minor scratches or scuffs not eliminated using paper towel or cloth can usually be removed by using a 'Magic Eraser'. Magic Eraser is a melamine foam product available at any grocery store or home improvement center. Dampen the entire glass surface as well as the Magic Eraser, then rub the entire glass surface in broad, even strokes using moderate pressure. Clean and dry the surface with a paper towel. Check for results and repeat as necessary.

Any scratches or scuffing not eliminated by one of the above methods can often be addressed by 'refreshing' the glass. This is a process that should not be required more than once per 6-12 months. See this brief video for the simple method: www.bdiusa.com/glass

WOOD

Wood surfaces should be cleaned with a slightly damp (not saturated) cloth or paper towel. Do not use glass cleaner on wood. If moisture remains, dry the surface with another cloth. If needed, a gentle non-abrasive cleanser may be used, but be sure to wipe away all cleaner residue and dry the surface with a cloth.

BDI's wood finishes feature natural hardwood solids and veneers. Wood is a product of nature and—unlike man-made materials that can be manufactured to strict and consistent specifications—has natural imperfections that are part of its appeal and character. Every piece of wood differs from every other, even when coming from the very same tree. As such, variation in grain, texture and tone should be expected from one panel or piece of furniture to the next.

While BDI's stained wood finishes are stable in tone & appearance, all finishes are subject to some degree of discoloration with prolonged exposure to direct sunlight. Please take care to avoid positioning your BDI cabinet in any area with extensive direct sunlight. To learn more about the features of natural wood, visit www.bdiusa.com/wood

METAL & PAINTED SURFACES

Surfaces should be cleaned with a slightly damp (not saturated) cloth or paper towel. If moisture remains, dry the surface with another cloth. If needed, a gentle non-abrasive cleanser may be used, but be sure to wipe away all cleaner residue and dry the surface with a cloth.

WARRANTY

BDI warrants to the original purchaser that for the below stated warranty term, BDI will repair or replace any product, part, or component covered by this warranty which fails under normal use as a result of a defect in material or workmanship. BDI will repair or replace the aforementioned product, part or component with a comparable product, part or component. The decision to repair or replace will be at BDI's sole discretion.

BDI Home Theater Furniture, Office Furniture, Modular Systems, Tables and other furniture pieces are warranted for three (3) years from the date of purchase as shown on your sales receipt. The warranty period starts from the date of purchase. This warranty extends only to the original purchasers who acquire new product from BDI Authorized Resellers. Any product, part, or component must have been assembled, installed, used, and maintained according to BDI's published instructions in order to be eligible for warranty coverage. Any modification to the original product voids the warranty.

To view BDI's complete warranty information, visit www.bdiusa.com/warranty

PRODUCT REGISTRATION

Registering your new BDI product allows us to send you important product updates, service information and helpful hints related to your BDI products. Register today, and you will be entered to win free a BINK table from BDI: www.bdiusa.com/register



WARNING

SERIOUS OR FATAL CRUSHING INJURIES CAN OCCUR FROM FURNITURE TIP-OVER. TO HELP PREVENT TIP-OVER:

- Install tip-over restraint.
- Place heaviest items in lower compartments.
- Never allow children to climb or hang on drawers, doors or shelves.
- Never open more than one drawer at a time.

USE OF TIP-OVER RESTRAINT MAY REDUCE—BUT NOT ELIMINATE—THE RISK OF TIP-OVER.



BDIUSA.COM

These distinctive product configurations are protected by US and international patents, trade dress, and/or copyright laws. Corridor & BDI are trademarks of Becker Designed, Inc. All rights reserved. ©2020, BDI | V.08.24.2020

Made in China.